

Technical data sheet

All right reserved Landa illuminotecnica S.p.A.
will reserve to change the specific note without
any written notice.

LANDA[®]
illuminotecnica

Lyras 80

Article 465GU5.3X2
Product type Wall Light
Body material Die-casting aluminium EN47100, prior the painting process, washed with stones. Painting made by polyester powder with high resistant against oxidation. Ring in die-casting aluminium EN47100
Tempered glass diffuser in transparent 10mm thick and silicon gasket.
Screws in A2 stainless steel
Bulb not included - Transformer not included

IK08
IP66
850°C

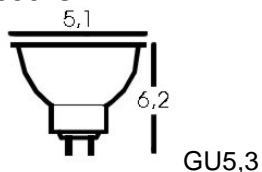

Bulb suggested - not included

2x35W Halogen
2x8W LED Megaman
2x8W LED Osram Parathom



Colours available:

Graphite



nhg

Metalgrey

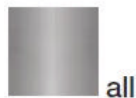

all

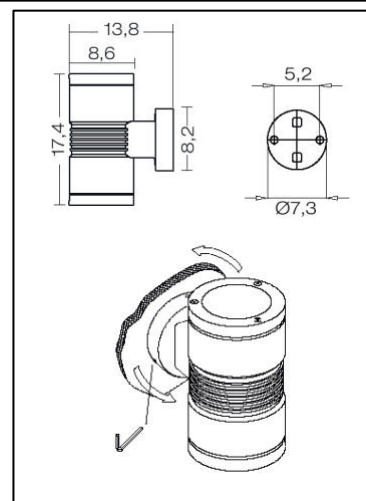

Accessories on request:



code 00K465.02
Reflector for art. 465



code 00K465.01
Visor for art. 465

Light effect: